

July 01, 2021 – 13:40 – Impulsvortrag

DynamicMold: Plastik wird intelligent

Dr. André Bernard | matriq AG | St. Gallen | Switzerland | matriq.ch

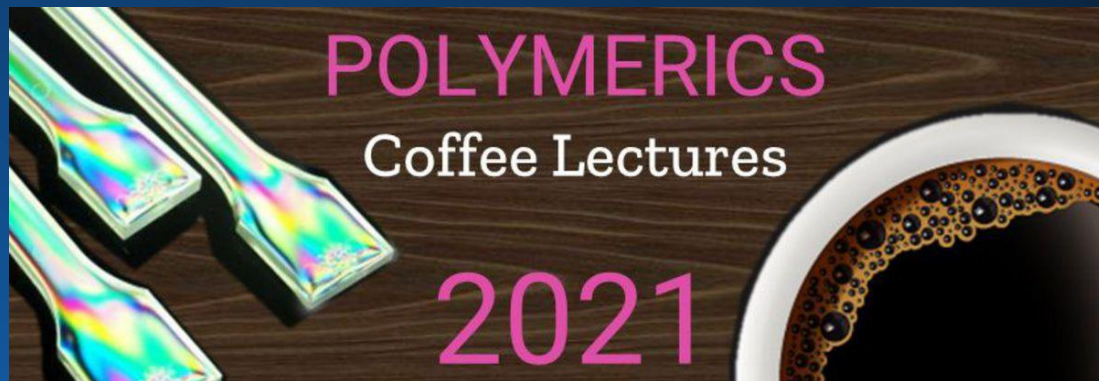

The unique watermark for plastics!

what it enables



traceability

identity



brand trust



industry 4.0

why it's needed



legislation compliance



track and trace along
its life cycle



managing recall
campaigns



quality control
process details



brand protection
consumer trust

matrix



customer need marking on their products



PLATE #F5G0007
POPULATION #
12/JAN/05
LOT 22



market opportunity: market sizes in 2020

injection
molded
plastics

265bn

(4.6%)

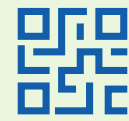

coding
marking

5.5bn

(5.5%)

injection
molder

14'000

IM machines

200'000



injection
molded
medical
plastics

1.2bn

(8.2%)

(CAGR)

the problem: marking is needed but complex

fabrication



handling, placing

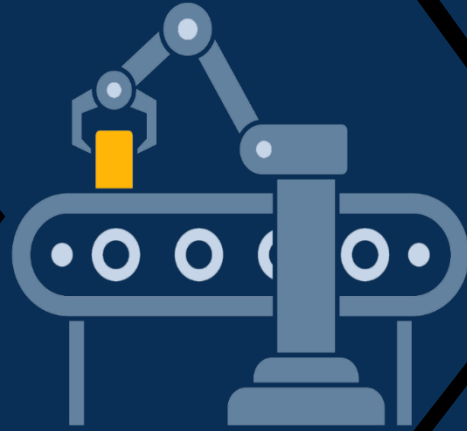

down-stream processes

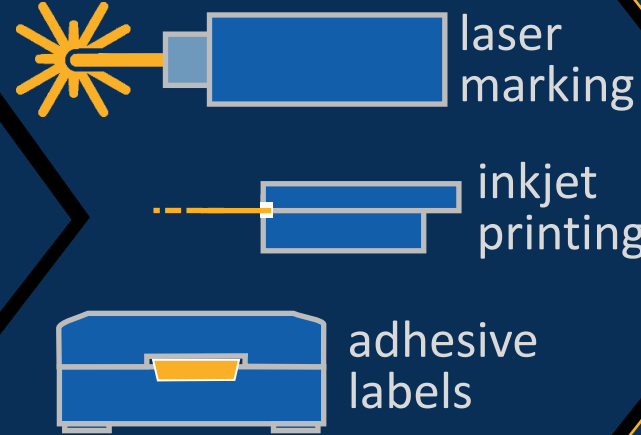

marked pieces



fabrication & marking

marked pieces

DynamicMold



- + **in-mold vs. down-stream**
- + faster production
- + no additional space
- + less complex, less costly
- + no polymer additives needed
- + «digital twin» right at birth

our innovative solution: *DynamicMold variable marking*

video link: youtu.be/ED-mdkb_Q54

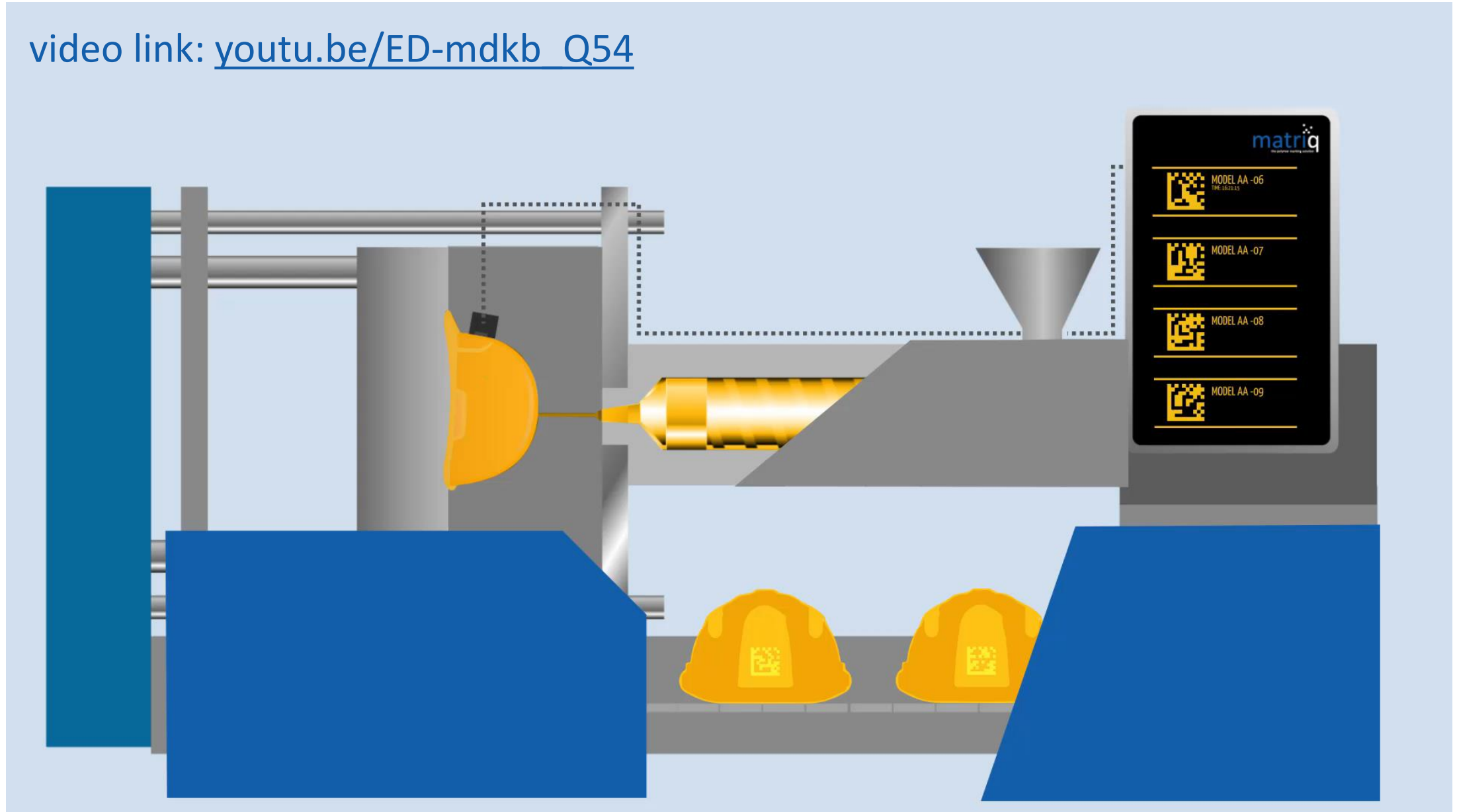

innovation: in-mold dynamic marking of plastics

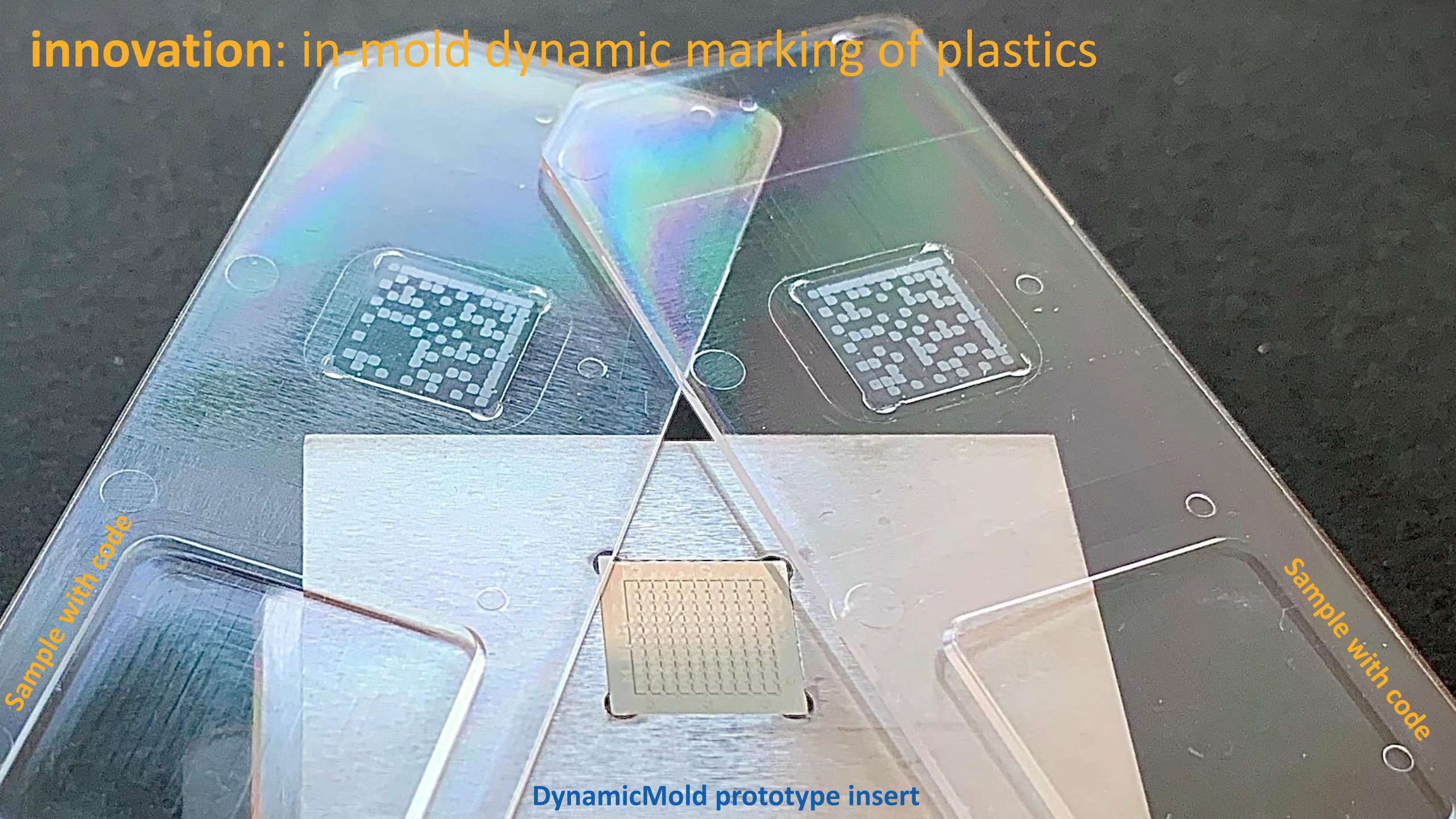

Sample with code

Sample with code

DynamicMold prototype insert

DM-date: *world's first true digital date stamp*

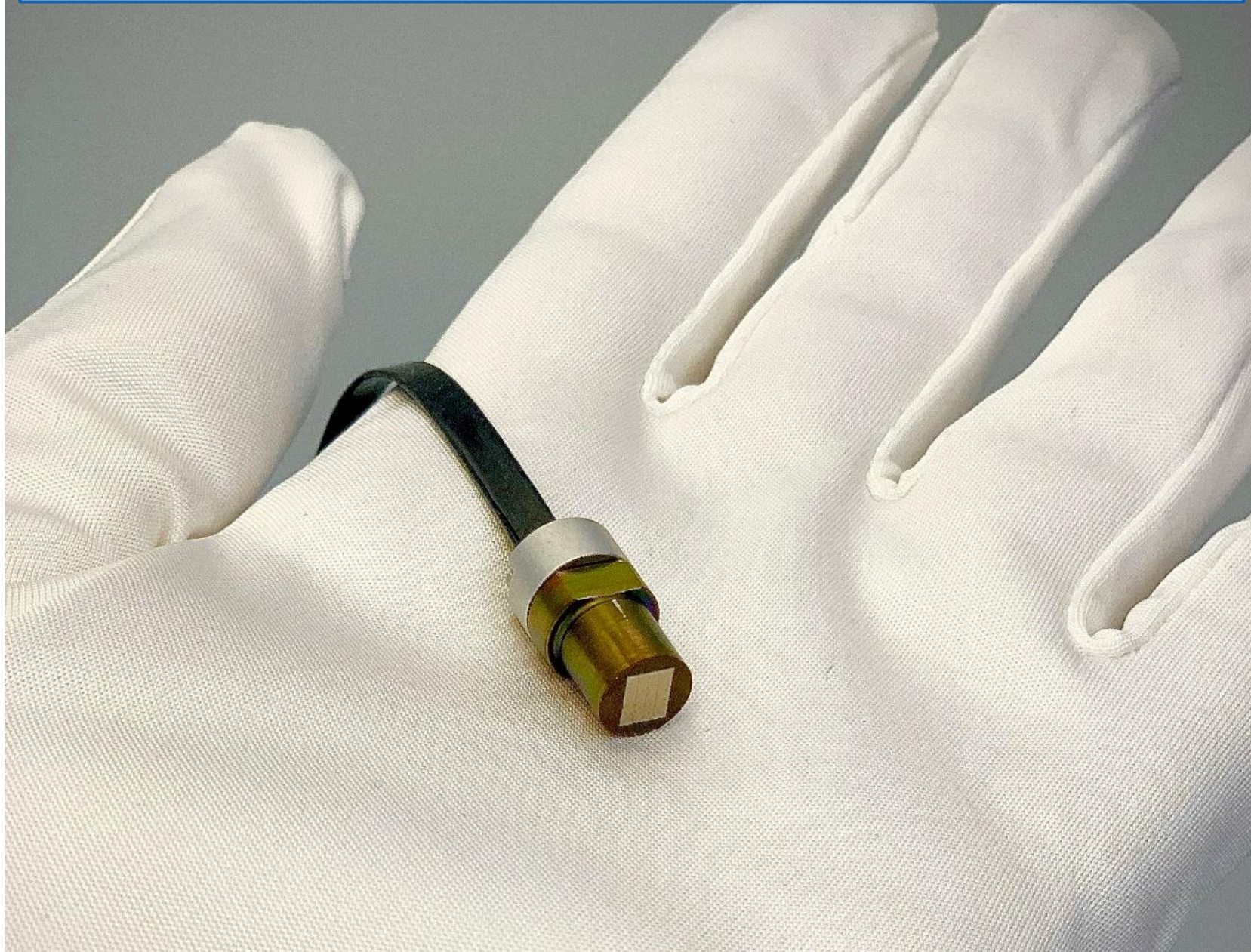

manual date stamp

matriq's DynamicMold insert: turn-key solution for marking

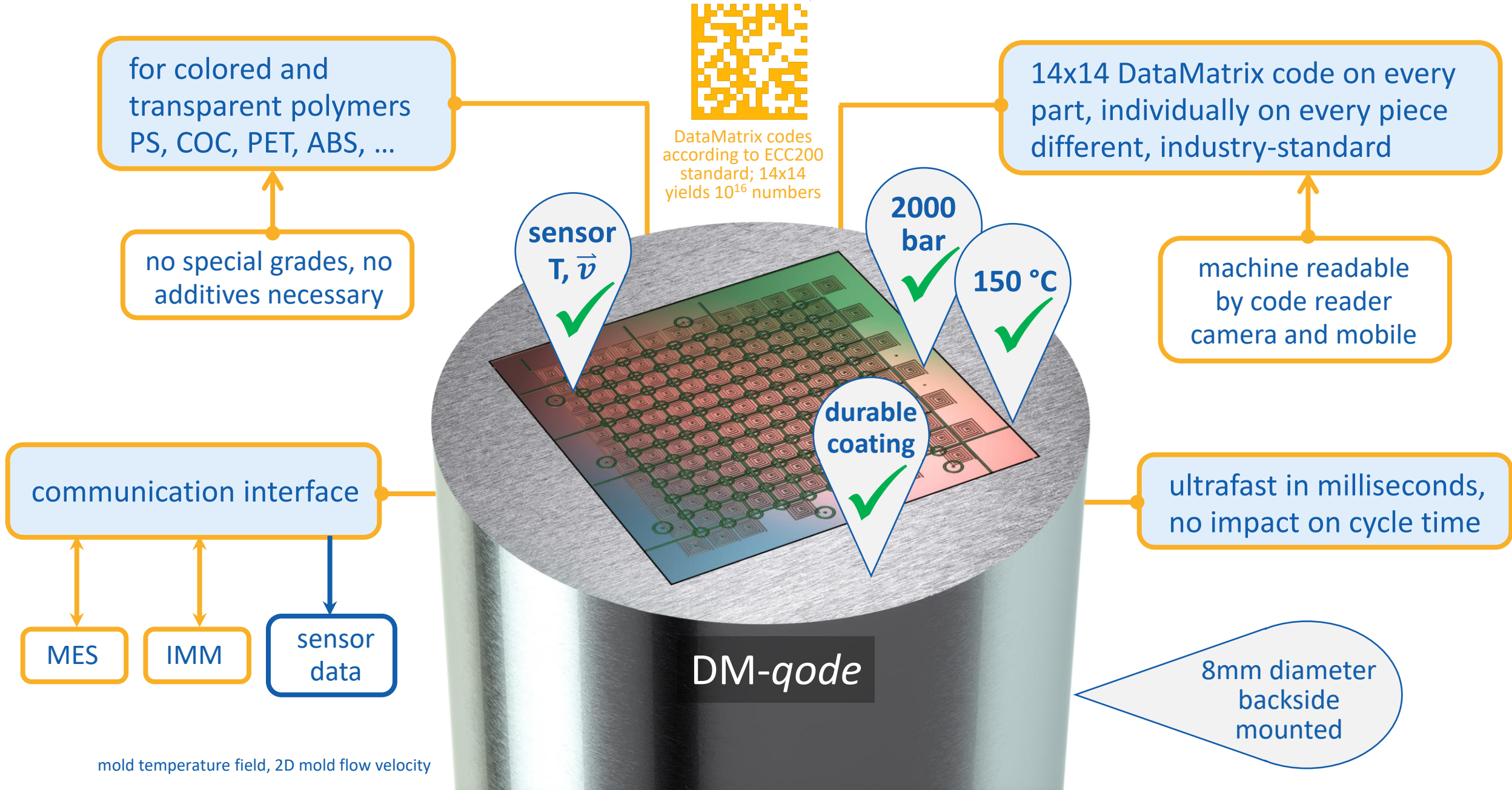

DynamicMold creating the digital twin

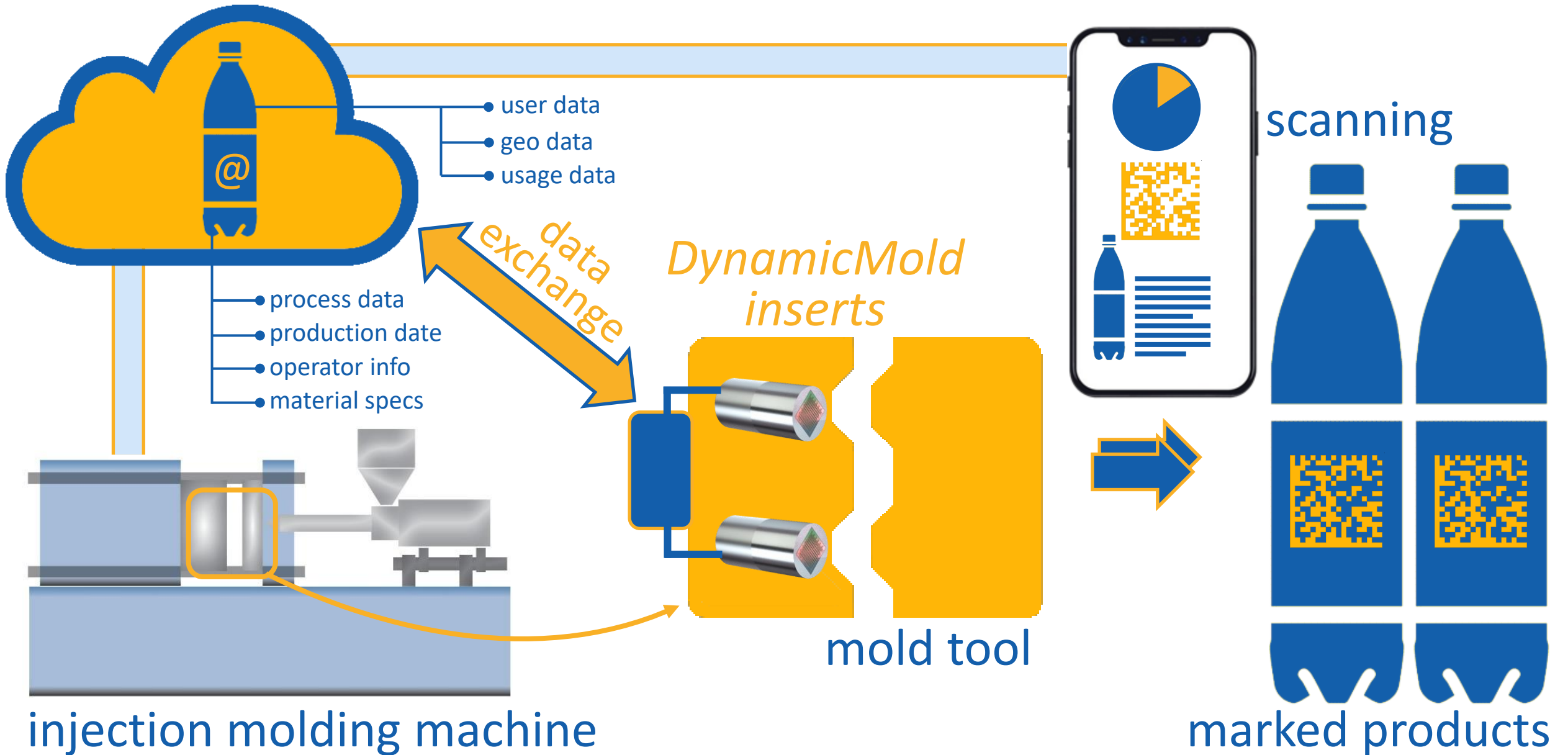

DataMatrix codes generated in milliseconds

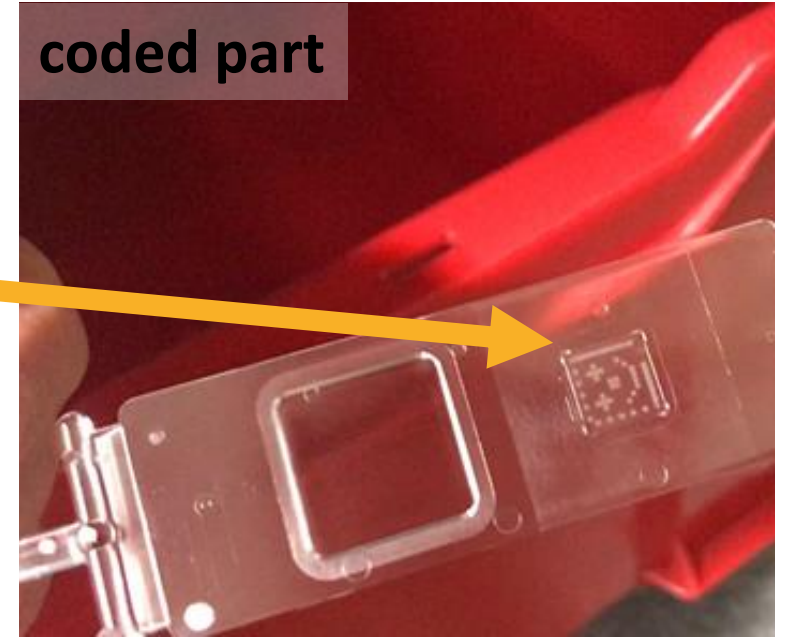
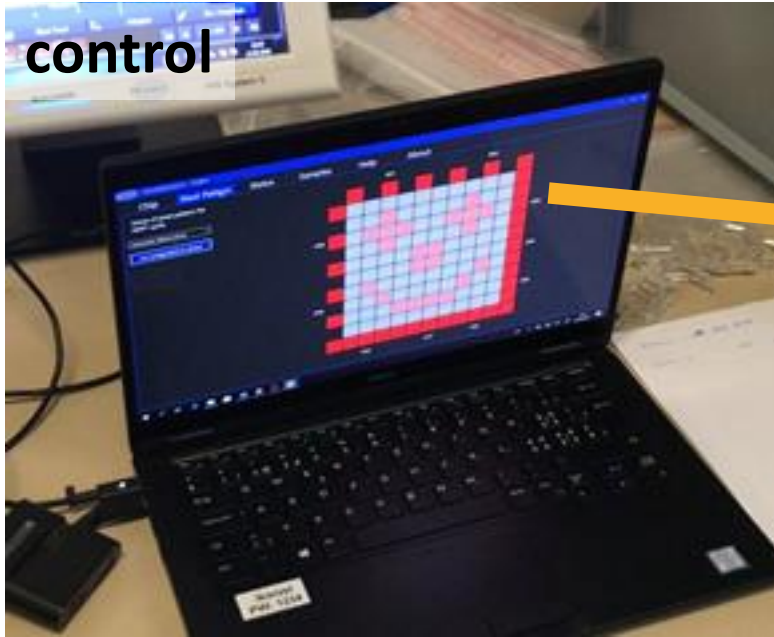

no additional time

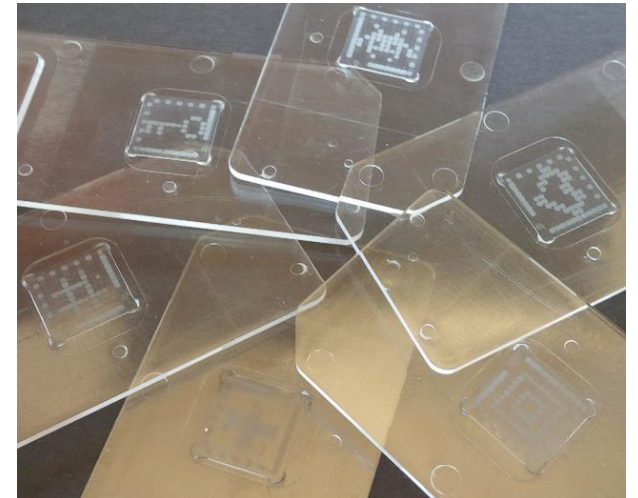
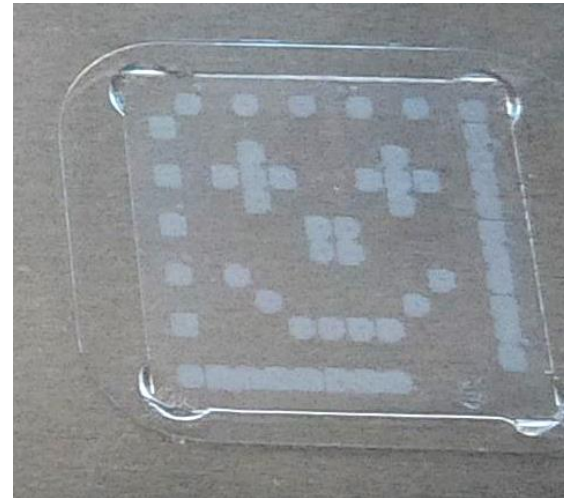
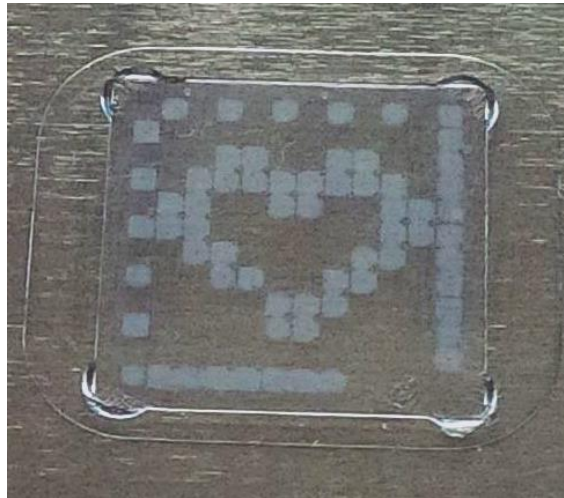
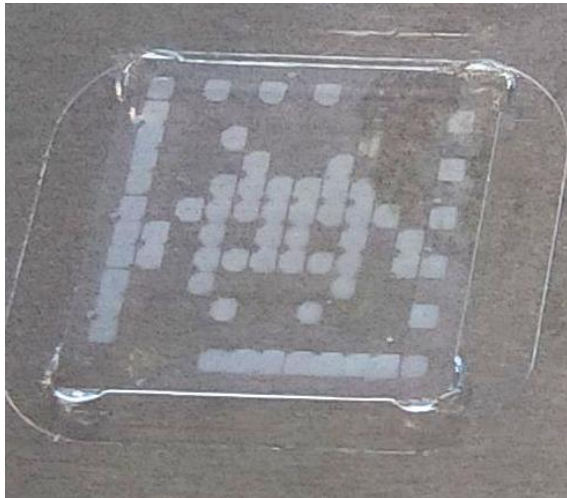

challenges for micro/nanosystems at in-mold applications

lifetime of **500'000**
cycles

> 250 individually
addressable heaters:
complex high-power
wiring → ASIC

sticking & **abrasion** of fiber-
reinforced polymers (frp)
→ **hard coating**

packaging for ultra **harsh environment**
at **hundred thousands heavy load cycles**

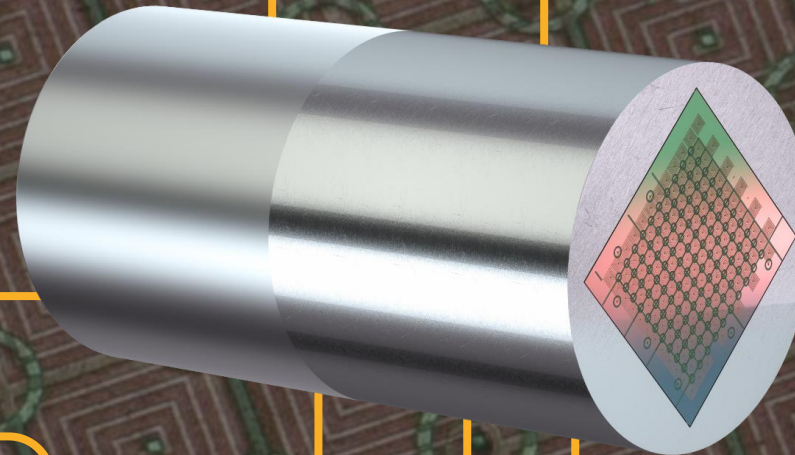

pressure up to 2000
bar (**200 MPa**) →
1'000 kg onto chip

working temperature
up to **150 °C**

heating power – high current
flows – **electromigration**

matriq's ASIC for a miniaturized smart DM-*qode*

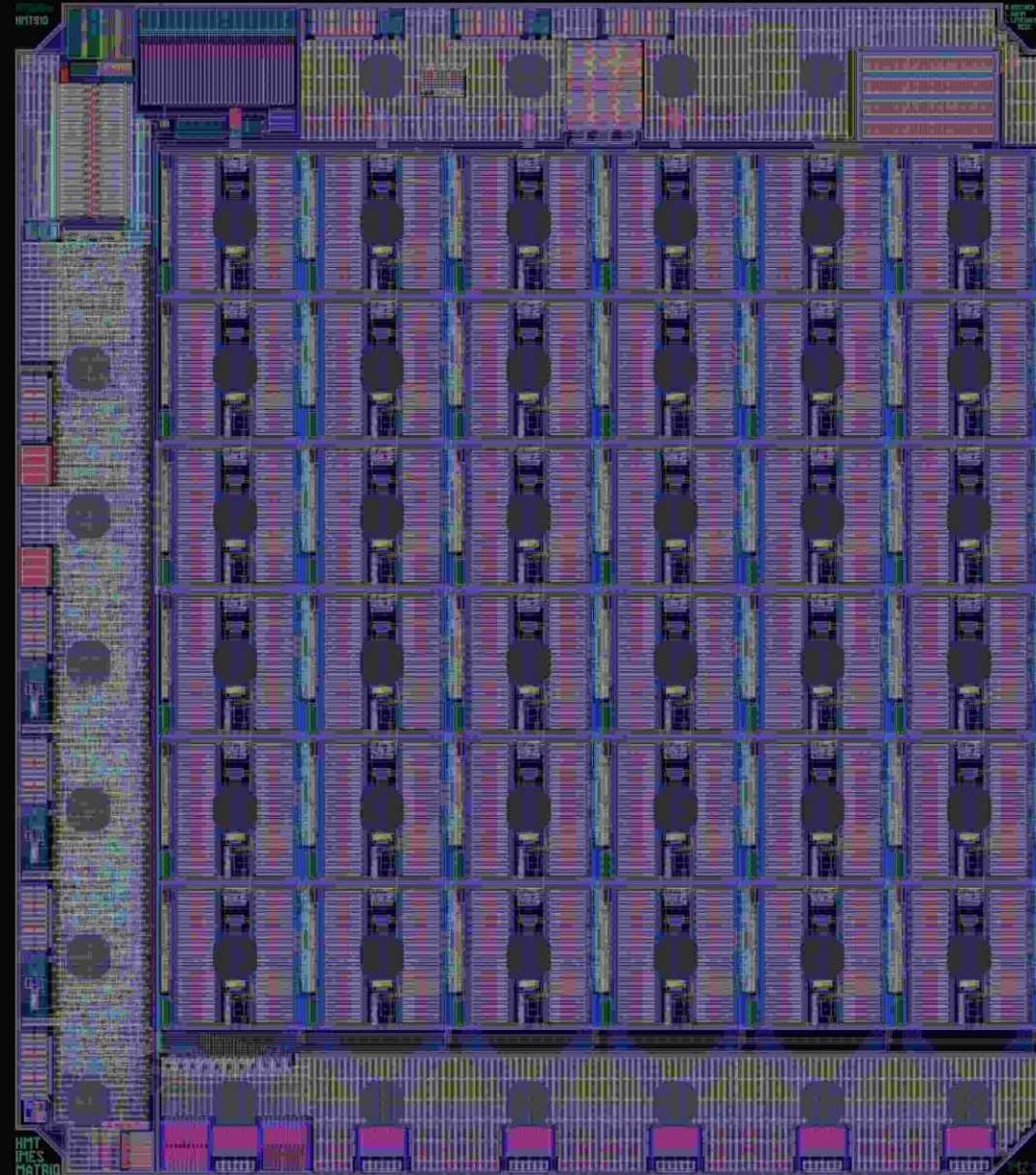

hardware: our product portfolio plan

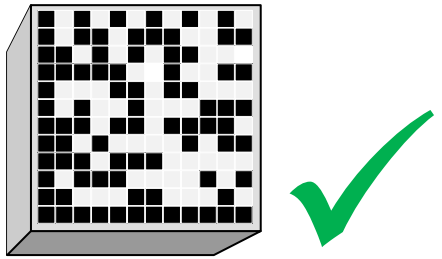

DM-*proto*¹²

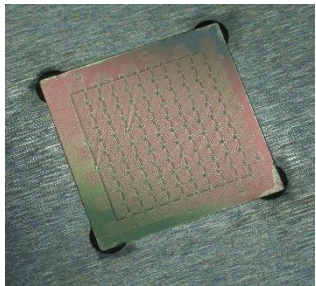

- prototype
- code 12x12
- area 10x10 mm²
- injection molding
- PS, 100'000 cycles

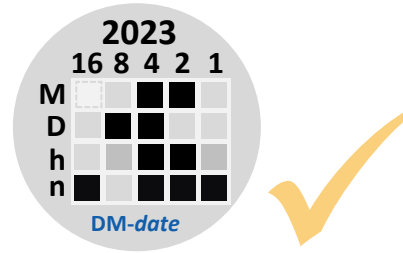

DM-*date*

MVP



- code 4x5 «date stamp»
- size Ø 8mm
- **injection molding**
- customized:
DM-*brand* and DM-*mate*

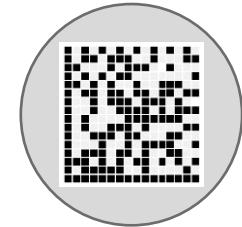

DM-*qode*¹⁴

flagship



- code 14x14
- area 6x6 mm² / Ø 8mm
- **injection molding**, thermo forming, blow molding, hot embossing



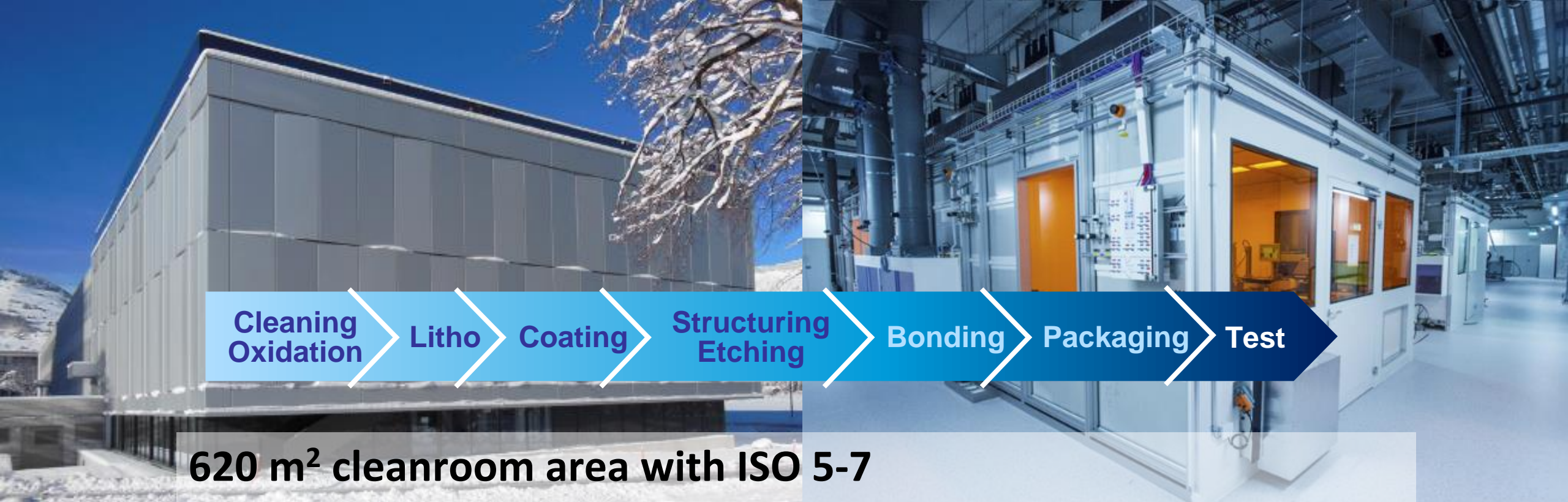

620 m² cleanroom area with ISO 5-7

- RR4: Experimental cleanroom
- RR6: Dry etching (ISO 6/7)
- RR7-Litho (ISO 5), RR7-Cleaning (ISO 6), RR7-Coatings 1 (ISO 7), RR7-Coatings 2 (ISO 7), RR7-Metrology (ISO 6)

Infrastructure und equipment for 4"-8" wafers (100-200mm)

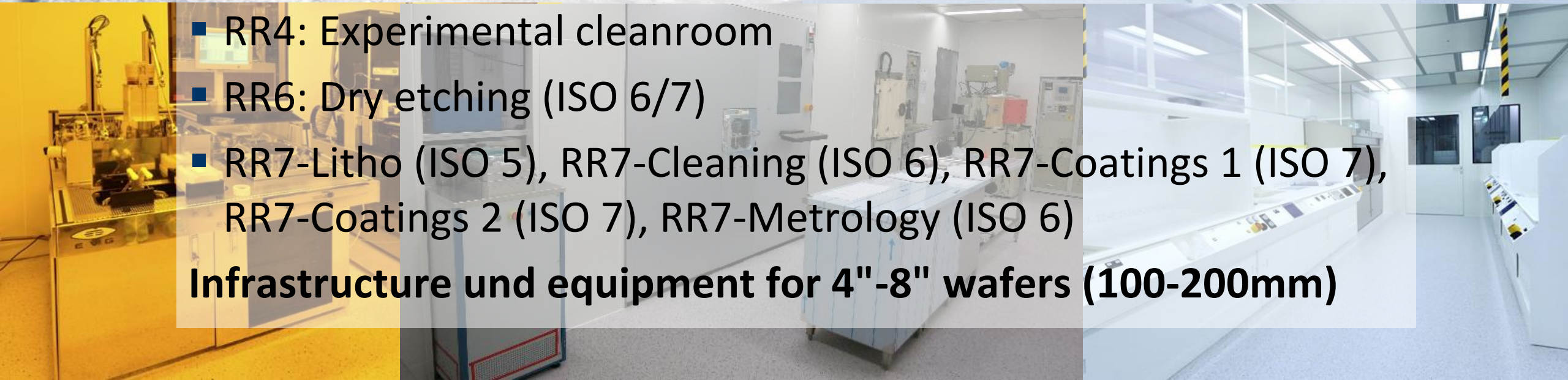

the **matr*iq*** team

matr*iq*



iq



partners and collaborators

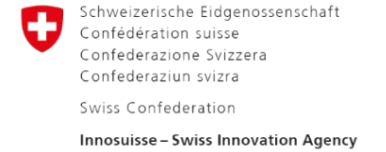
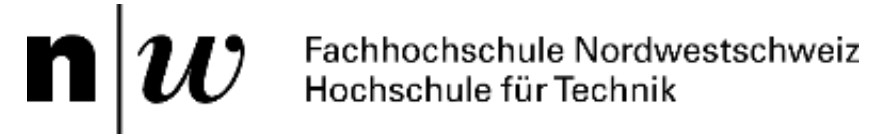

board of directors



advisory board

consulting supporter

matriq in a nutshell



- October 2019
- NTB Spin-off



- >2.5 MCHF for R&D
- 2 Innosuisse projects
- eurostars, *EIC accelerator*
- recognition, awards, prizes



- IP @ matriq
- patent granted
- freedom to operate



- 16 team members
- 10.3 FTE (1.6.2021)



- capital invest: >2 MCHF



@Startfeld Innovation Center
Lerchenfeldstr. 3, 9014 St. Gallen
Switzerland
matriq.ch

**START
FELD**

Foundation
Selection 2019

**VENTURE
KICK**
KICKSTART
YOUR HIGHTECH
BUSINESS

>>venture>>
Companies for tomorrow

**TOP
100**
SWISS STARTUP AWARD

π zkb
pionierpreis
technopark



+ Schweizerische Eidgenossenschaft
Confédération suisse
Confederazione Svizzera
Confederaziun svizra
Swiss Confederation
Innosuisse – Swiss Innovation Agency