

The logo icon consists of two overlapping, rounded shapes that form a stylized 'g' or 'x' shape. The top shape is slightly offset to the left and the bottom shape is slightly offset to the right, creating a central negative space.

medmix



Sustainability in the digital development process

Tobias Bodenmüller, Technology Expert - Sustainability

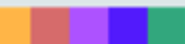

Business snapshot

CHF
~450m
revenue
(expected 2021)

2,000
employees

Global
footprint

13
production
sites

900+
active patents

8
brands

>2.5bn
Products per year

We help millions of people live a healthier and more confident life

Healthcare

Consumer and Industrial



Dental



Drug Delivery



Surgery



Industry



Beauty



For your perfect smile



For your health



For your active lifestyle



For your precision work





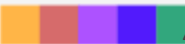



For your beautiful face





Environmental Sustainability Commitments

medmix approach to environmental sustainability brings Innovation to life...

...and drives our future commitments until 2025

-  Eco design principles embedded in innovation and R&D
-  Member of UN Global Compact
-  Committed to Science Based Targets initiative
-  Low carbon electricity used by 69% of all medmix sites
-  CDP Climate Change "Awareness" rating
-  EcoVadis assessments to drive improvement
-  ISCC audit to enable responsible sourcing

-  Achieved
-  Targeted





- Achieve SBTi Near Term CO₂(eq.) reduction (Net Zero by 2050)
- Increase availability of sustainable products
- Zero waste to landfill
- Low carbon electricity for all sites
- ...

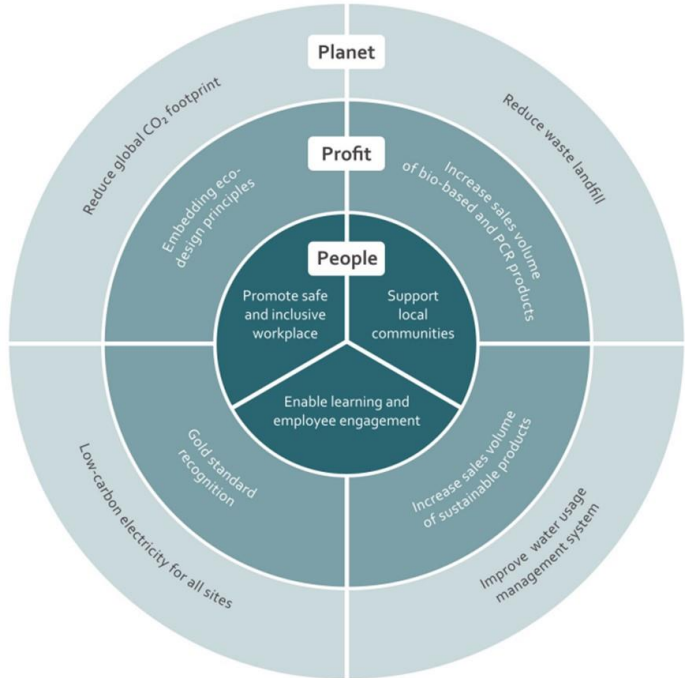

Industry – overview

Selected products



2-K Cartridges
(from 10ml to 1,500ml filling volumes)

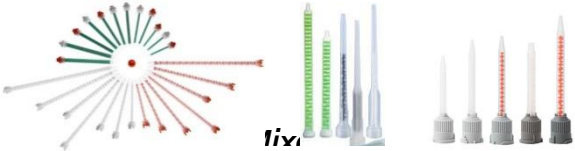

1- and 2-K Dispensers
(manual, pneumatic, battery-driven for one- or two-component)

Selected applications

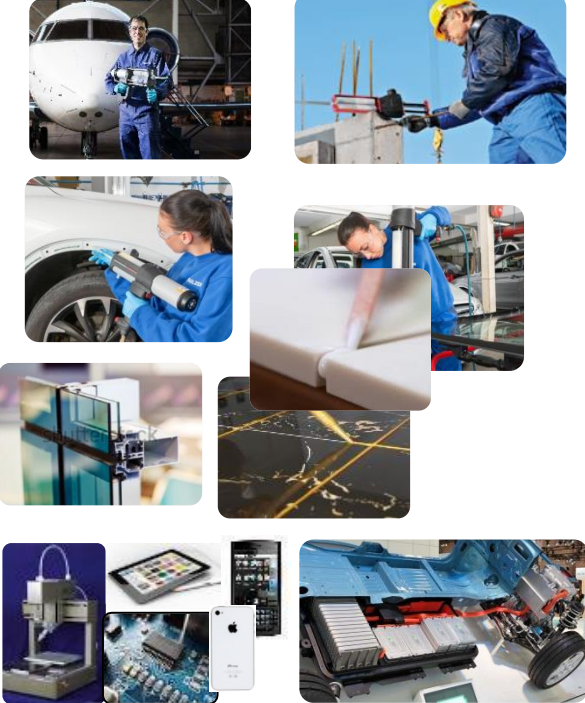

Construction, transportation (e.g.: aerospace, automotive), electronics (e.g.: smart phones), infrastructure

Product development

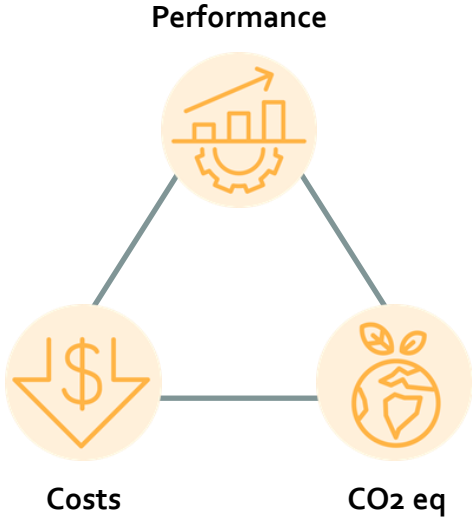
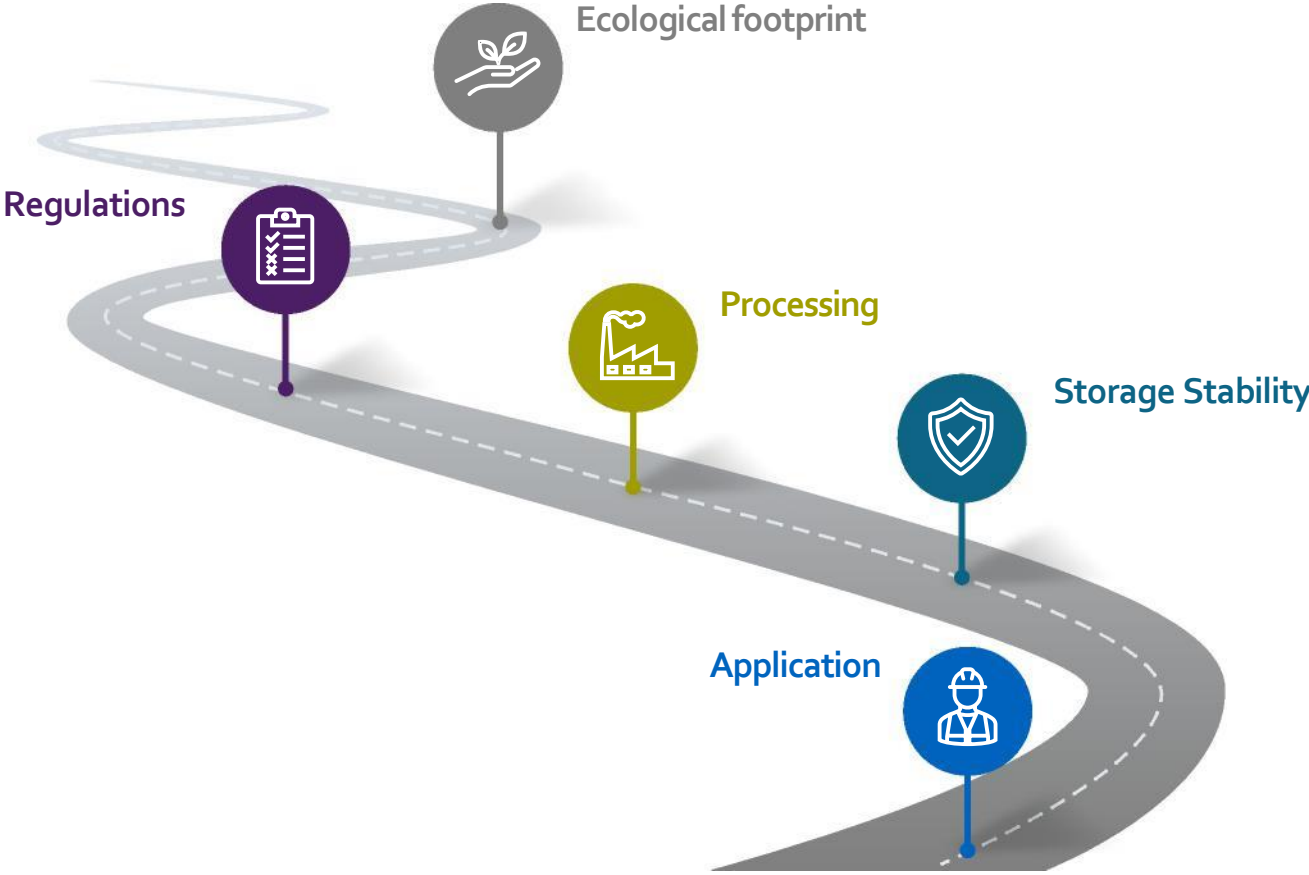

Digital development process





Simulation Landscape

- Injection molding simulation
- Structural simulation
- Fatigue analysis
- CFD analysis
- Life Cycle Assessment

FEA interface

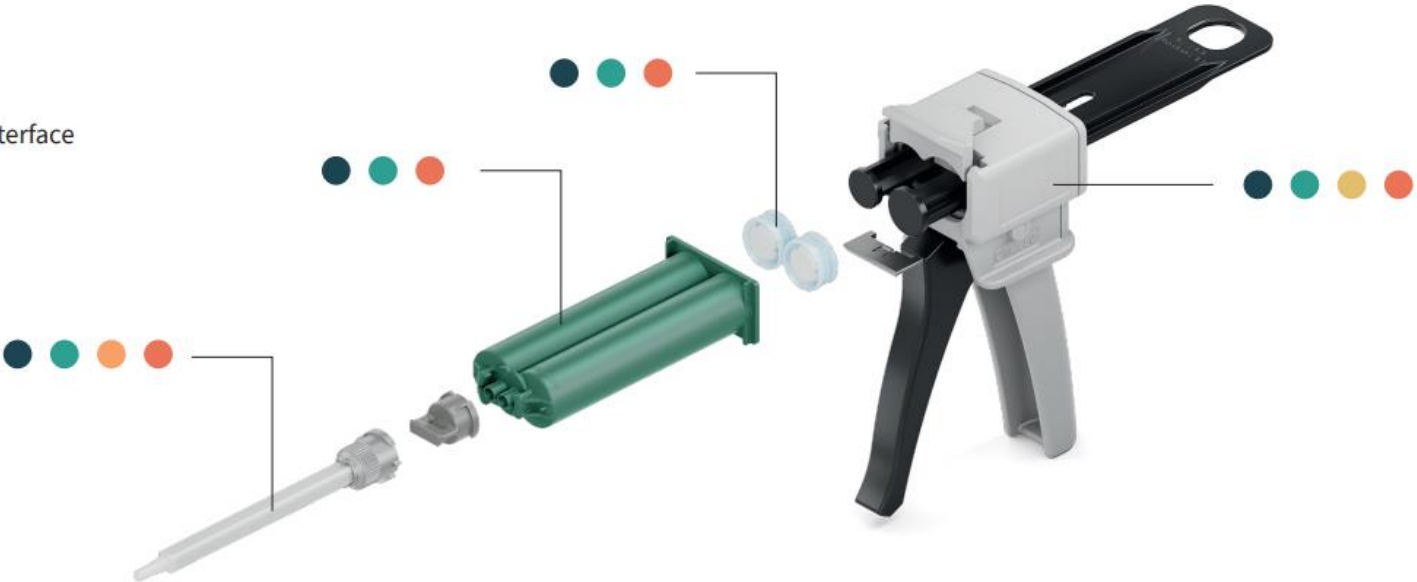

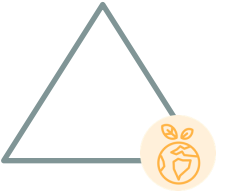

Life Cycle Assessment

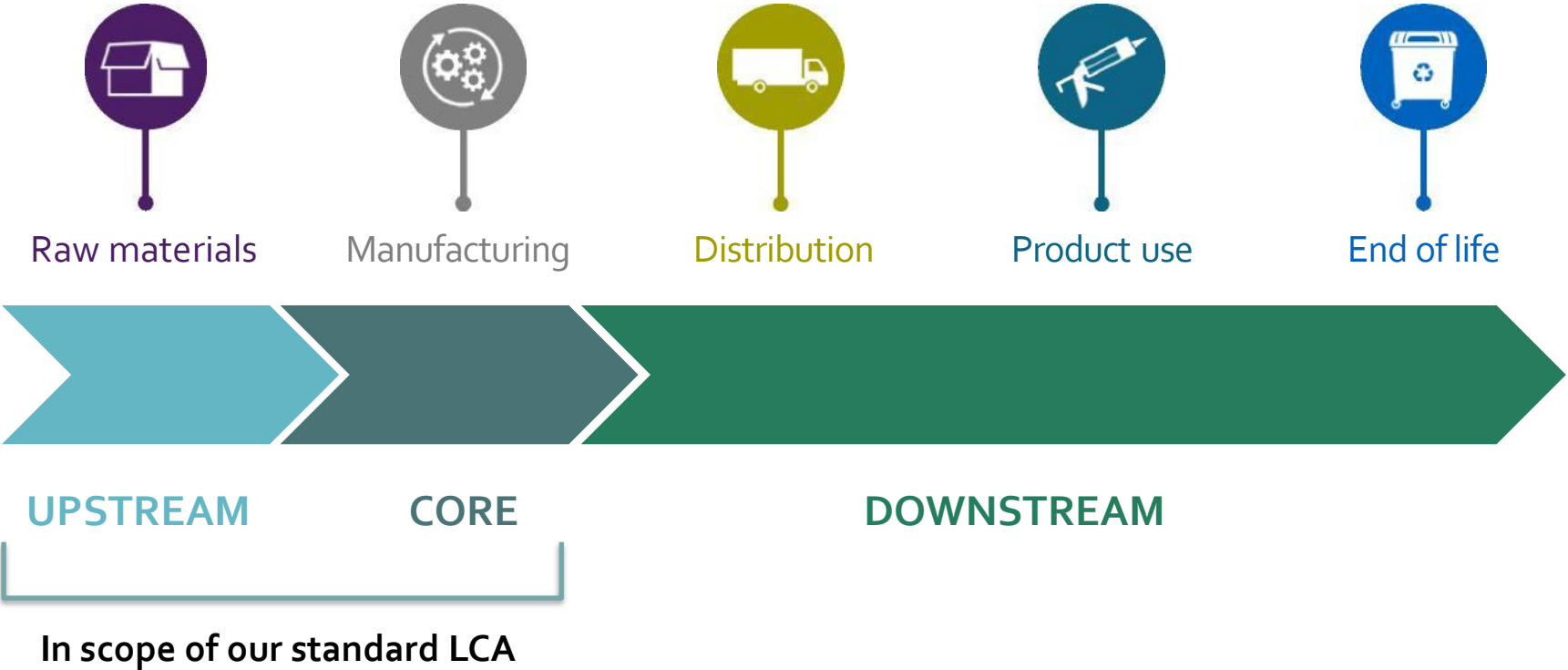

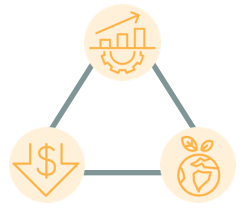

Drop in solution

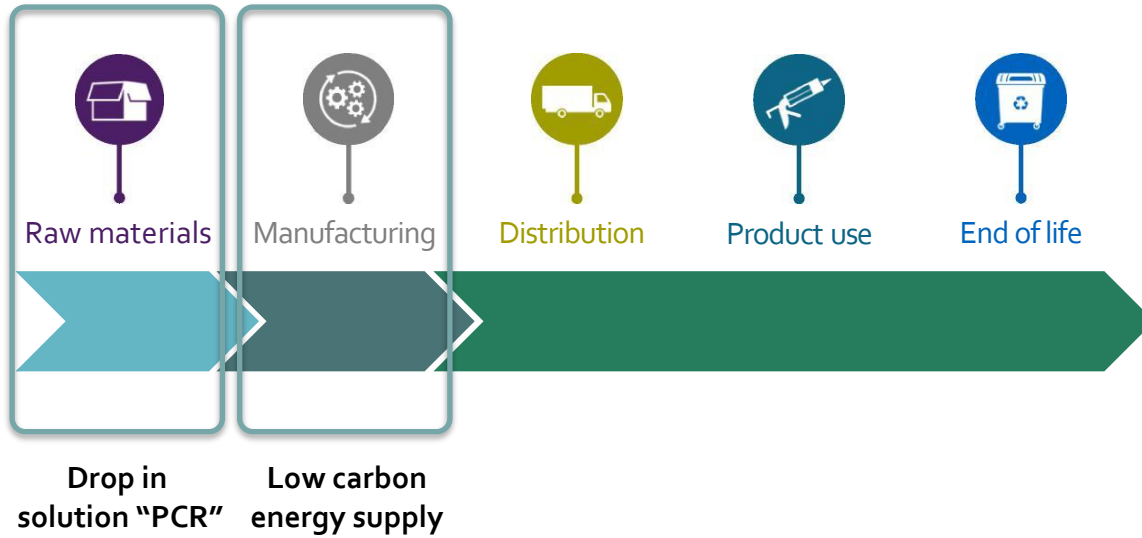

100% recycled PCR PP cartridge, 50ml

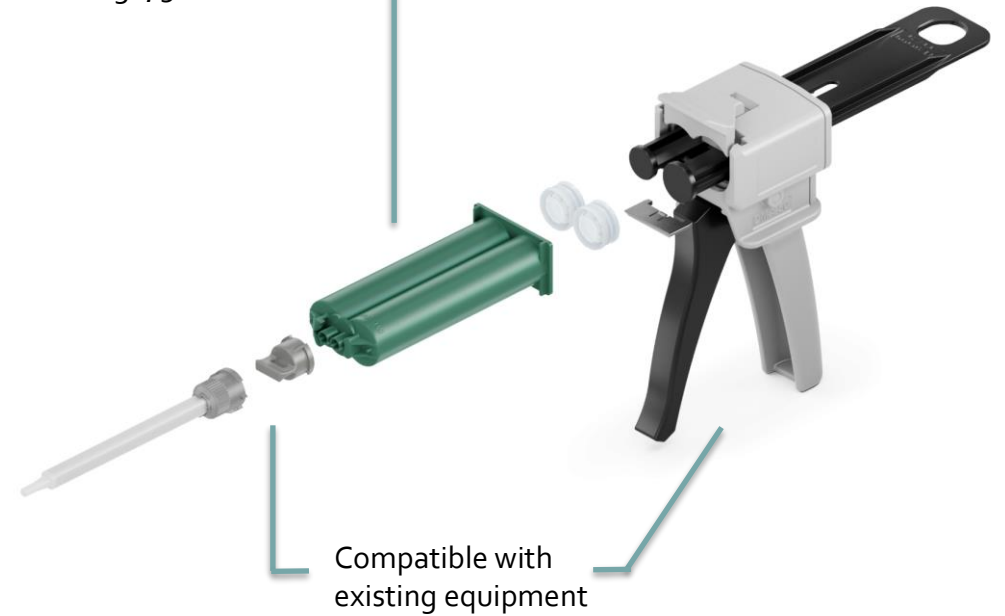

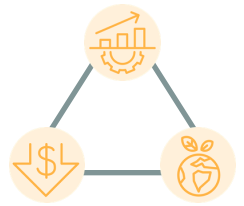

Drop in solution

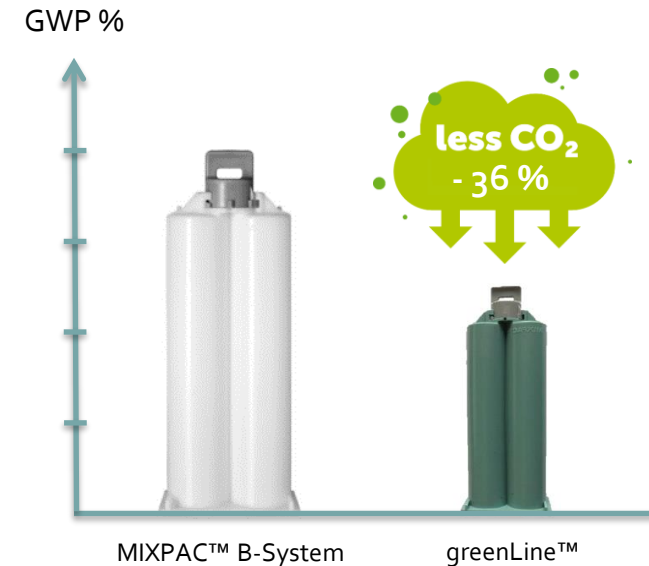
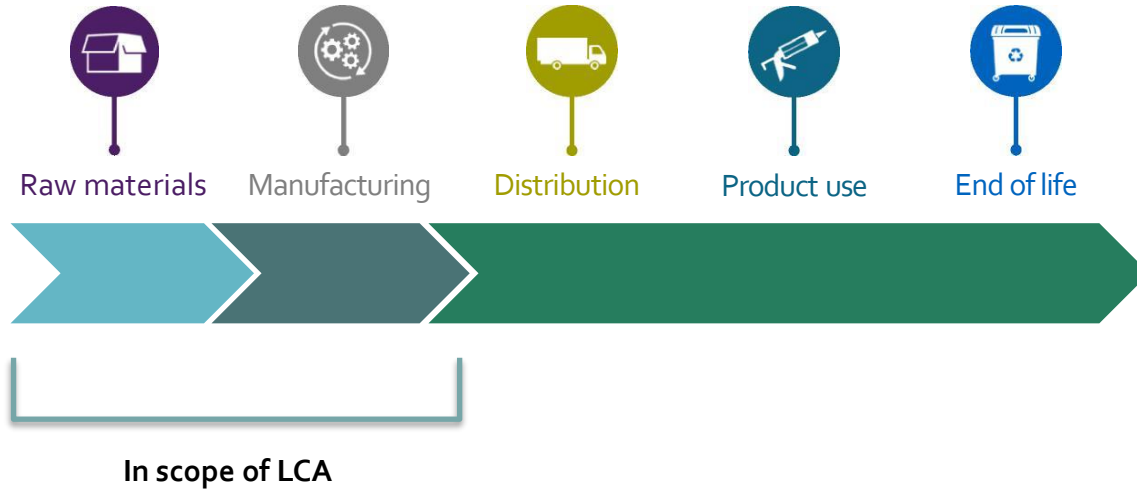

Internal LCA, Methode: IPCC 2021 GWP100

medmix has decided to calculate the carbon footprint of some of its products and share this information with its business customers. You may use this information for calculating the carbon footprint of those of your products which have been manufactured using medmix products. Any further sharing of medmix' carbon footprint data is not permitted, unless explicitly approved by medmix in writing. This data is provided without any guarantee and any and all liability in connection with the use of this data is herewith explicitly excluded.





More sustainable solution

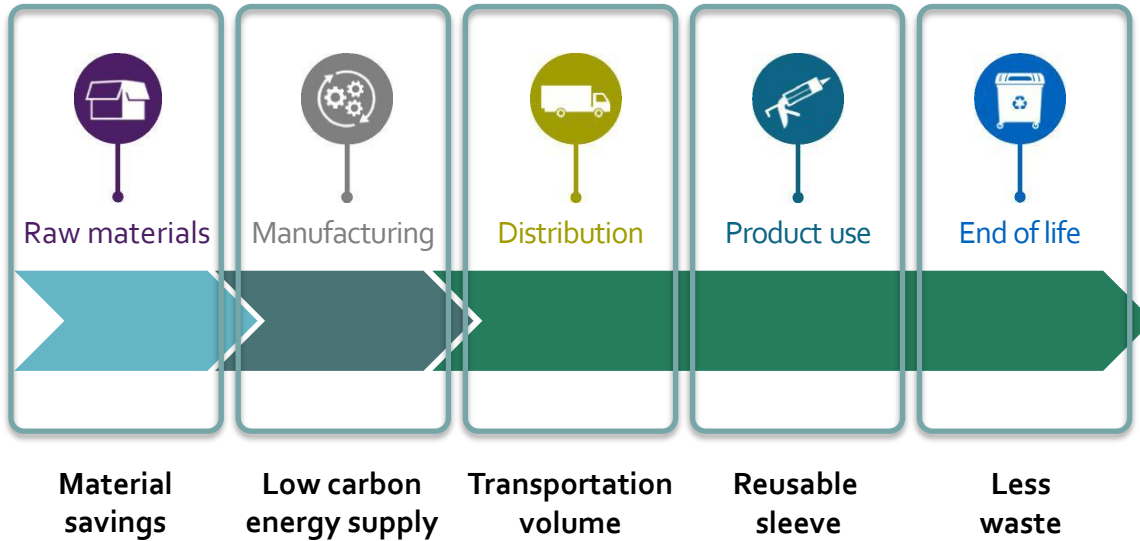

Support sleeve with integrated pistons (reusable)

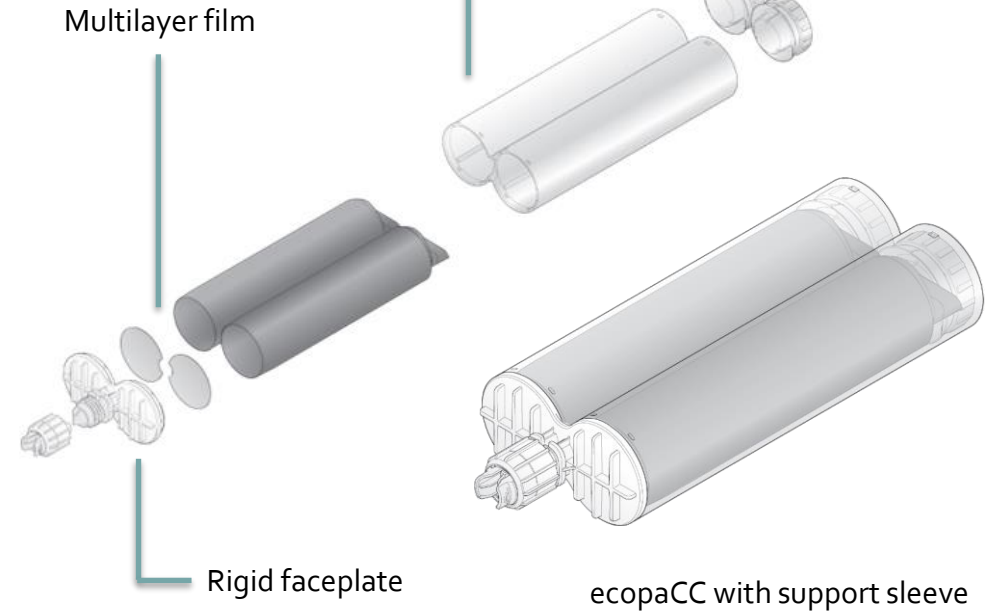

Fully compressed
Minimal waste



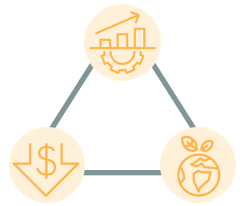

More sustainable solution

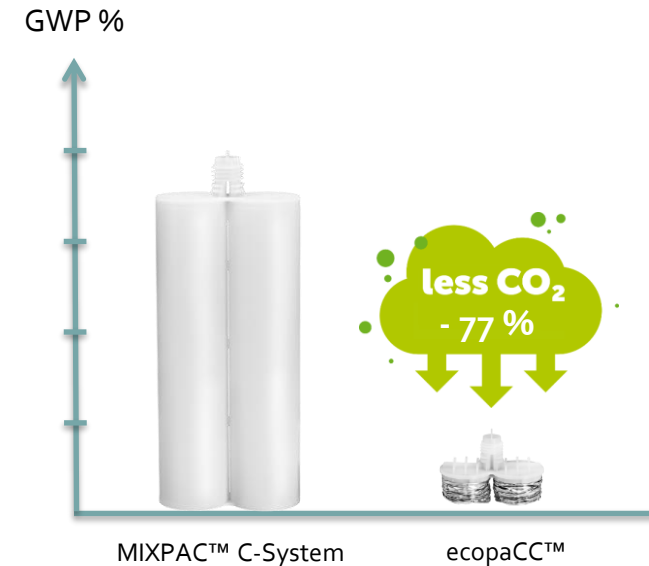
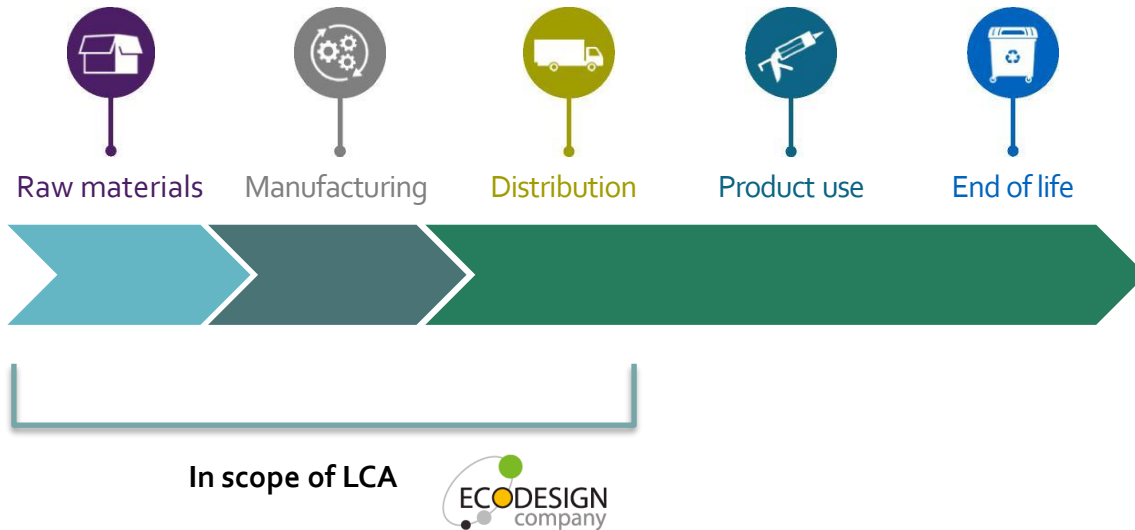

Internal LCA, Methode: IPCC 2013 GWP100
Support sleeve calculated for 1000 uses

medmix has decided to calculate the carbon footprint of some of its products and share this information with its business customers. You may use this information for calculating the carbon footprint of those of your products which have been manufactured using medmix products. Any further sharing of medmix' carbon footprint data is not permitted, unless explicitly approved by medmix in writing. This data is provided without any guarantee and any and all liability in connection with the use of this data is herewith explicitly excluded.



Any questions

medmix Switzerland AG

Ruetistrasse 7

9469 Haag, Switzerland

Phone +41 81 414 70 00

Sales.industry@medmix.com

www.medmix.swiss



Legal notice

This document is a general presentation. The information contained in this publication is believed to be accurate and reliable but is not to be construed as implying any warranty or guarantee of performance. We waive any liability and indemnity for effects resulting from its application. Please, contact us for a description of the warranties and guarantees offered with our products. Directions for use and safety will be given separately. All information herein is subject to change without notice. medmix owned photography and imagery from this document, our website and other sources may be used only with written consent. Contact medmix for permission.

Copyright © 2021 medmix Ltd. All rights reserved.