

IMPACT OF SMALL WEATHER DATA TIME STEPS ON THE SIMULATION OF SOLAR AND HEAT PUMP SYSTEMS

Martin Granzotto¹, David Chèze², Michel Y. Haller¹

¹ Institut für Solartechnik SPF, Hochschule für Technik Rapperswil HSR,

Oberseestrasse 10, CH-8640 Rapperswil, Tel. +41 55 222 48 21, martin.granzotto@spf.ch

² CEA LITEN – Institut National de l'Énergie Solaire INES BP 332, 73377 Le Bourget du Lac, France

Abstract

For the simulation of solar thermal systems mainly hourly based weather data are used today. The question arises whether short term fluctuations of e.g. solar irradiation that may be present in measured weather data with smaller time resolution has an impact on the result of solar thermal system simulations. To study the influence of weather data time resolutions, different systems that combine solar collectors and heat pumps were simulated twice in TRNSYS17. One time with a weather data time resolution of six minutes, and one time with hourly averaged weather data from the same source of measured weather data from Zurich (Switzerland). Starting with a reference solar and heat pump system simulation, single parameters of the system were varied (e.g. collector area, thermal capacity, specific mass flow rates through the collector loop) in order to analyse the dependency of the difference between small time resolution and hourly weather data simulations. In general, the influence of weather data time resolution was higher when using stratifying charging in the thermal energy storage, for large collector areas, and for large specific mass flow through the collector field. The difference of seasonal performance factor, electricity consumption, and solar collector yields were about ± 1.2 % at maximum when hourly averaged weather data was used instead of six minute profiles.

1. Introduction

On partially cloudy days that are a frequent phenomenon for Middle European climates, irradiance on a collector field may change within short time frames of seconds or minutes. Averaging high resolution weather data to hourly values reduces fluctuations and may even out short term irradiance peaks. This may change the results for solar energy systems that do not respond linearly - e.g. solar thermal yield is zero below a certain irradiation level and is not linear above this level. A simple method of solar utilizability calculation has been presented by Duffie & Beckman (1980); Suehrcke & McCormick (1989) and used by Vijayakumar et al. (2005) in order to quantify the effect of using averaged - e.g. hourly - irradiation data. They have found that using hourly data rather than short term data can underestimate the performance of solar thermal systems anywhere between 5 % and 50 % (10 – 30 % for a critical radiation level of 200 – 500 W/m²), depending on the critical level for utilizability, on the climatic conditions, and on the month of the year. However, Baoxin (2009) presented simulations of solar thermal systems for space heating (SH) and domestic hot water (DHW) preparation, and found that the solar thermal yield was only reduced by 0.4 % when hourly averaged weather data were used instead of 6-min weather data. Their solar thermal systems were backed up by a natural gas burner and the climatic data was from a Swedish location. The large deviation between the 5 % - 50 % obtained from application of the utilizability method and the 0.4 % obtained from system simulations raises questions that shall be elucidated in this paper. For this purpose, this contribution investigates the influence of using high resolution weather data compared to hourly averaged values for the same climate. It is investigated whether certain parameters of the system design and control lead to increased deviations between results obtained with hourly averaged weather data and results obtained with higher time resolutions.

2. Methods

3.1 Weather data

The used weather data are based on a test reference year (TRY), which was created for the purpose of whole system laboratory testing (Vogelsanger 2002; Haberl et al. 2009; Haller et al. 2013) already more than ten years ago. Because of its history, the procedure for obtaining the hourly and six minutes values that are used in this study may not seem straight forward. The starting points are 10 minute time step data measured by Meteo Schweiz for Zürich-Fluntern (Switzerland) from 1994 – 1998. From these data, a TRY was created that included measured values for ambient temperature, relative humidity, and total irradiance on the horizontal. Values for total irradiance were processed in order to obtain smooth transients in time steps of 1/40 h. The Erbs correlation implemented in the TRNSYS 14 radiation processor was used in order to calculate diffuse and direct radiation on the horizontal and on the 45° inclined south oriented surface in time steps of 1/32 hours for. These values were later resampled to datasets with resolutions of 6 min (6-min-wd), and 60 min (1-h-wd) for use in other research projects. For the final system simulations standard Type 16i was used and a simulation time step of 2 minutes, irrespectively of the time resolution of the weather data (hourly averages or 6 minutes). Consequently, the instantaneous irradiation at a point of time may differ between the 6-min- and 1-h-wd simulations, but the daily integration of solar irradiance is the same for both.

3.2 Reference system

The SH load was simulated using standard Type 56 and the building definition of SFH45 of the IEA SHC Task 44 / HPP Annex 38 (Dott et al. 2013; Haller et al. 2013a). The climate was defined by the TRY weather data as explained above (location of Zurich instead of Strasbourg) which lead to an increased space heating demand of 59 kWh/(m²·a). The DHW profile was obtained based on statistical probability distributions with DHWcalc (Jordan & Vajen 2005), i.e. did not correspond to the DHW profiles defined in Task 44 / Annex 38.

An air source heat pump was used, because it is more dependent on weather changes than a ground source heat pump. The heat pump was designed to supply the design heat load with its nominal power (A2/W35). The heat pump has three pipe connections to the thermal energy storage (TES) at relative heights of 100, 49 and 26 % of the storage height (see Fig. 1). In space heating mode the middle connection is the supply from and the bottom connection is the return to the heat pump. For the charging of the domestic hot water zone of the TES the middle and top connections are used for return and supply to/from the heat pump. All system simulations were carried out with TRNSYS V17.01.0025. The simulation types and origins as well as the sizing of the different components are given in Table 1, a simplified hydraulic scheme in Fig. 1.

Table 1: Description of the main used types

Type	Description	Main parameters	Remarks, source
56	Multi-Zone Building	Space heating load: 59 kWh/(m ² ·a) Domestic hot water load: 3040 kWh/a	standard type, (Dott et al. 2013; Haller et al. 2013a; Jordan & Vajen 2005)
340v1.99 F	Thermal energy storage (TES)	Volume: 0.968 m ³	(Drück 2006)
832v500	Flat plate collector	Aperture area: 15 m ² Thermal capacity (with content fluid): 7000 J/(m ² ·K) Inclination: 45° Orientation: south (0° Azimuth)	(Haller et al. 2012)
877v112	Heat pump	Nominal Power: 5 kW Nominal mass flow rate: 872 kg/h COP: 3.5 at A2W35	Air source heat pump, (Heinz & Haller 2012)
31	Pipes	Heat loss coefficient: 13.7 kJ/(hK)	standard type, (Bales, 2012)

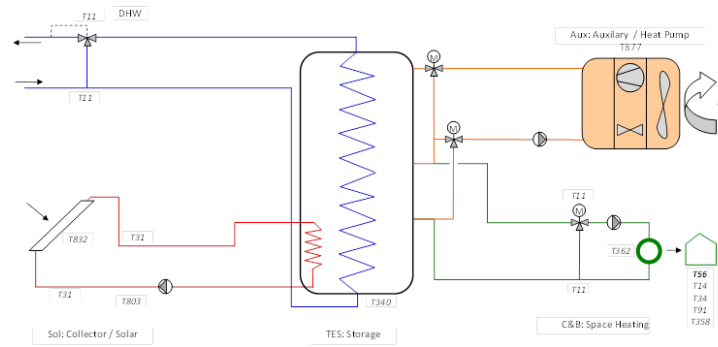
Figure 1: simplified hydraulic scheme of the simulated system

3.3 Control of the reference system

The heat pump starts when the temperature in the storage is lower than the set temperature minus a hysteresis of 3 K. For space heat supply this temperature is based on the ambient temperature dependent heating curve and for domestic hot water the set temperature is 55 °C

If the temperature difference ($\Delta T_{\text{coll,on}}$) between the TES temperature (at 18 % relative height of the storage) and the collector outlet reaches a value of 7 K the collector pump starts to run with an nominal flow rate of 40 kg/(h·m²). It will stop at a temperature difference of 3 K.

3.4 Parametric studies

Based on the system simulations with the reference parameters described above, a parametric study was performed where one or more system parameters were changed. The parameters that were varied and the values used are displayed in Table 2.

The parameters that were varied included

- The specific mass flow rate through the collector field (high flow with 60 kg/(h·m²), low flow with 15 kg/(h·m²), or match flow). For match flow simulations the temperature difference between flow and return of the collector loop is controlled to 10 K as much as possible by varying the flow rate between 30 % and 100 % of the nominal flow rate.
- The use of an external heat exchanger with and without stratified storage charging.
- Low thermal capacity of the collector field and collector pipes (reduction of pipe length).
- Different collector areas.
- Pipe insulation.
- Control values for collector operation ($\Delta T_{\text{coll,on}}$).

In Table 2, simulation 1 corresponds to the reference system.

In order to track down the cause for differences between results from the utilizability method and from system simulations, also unrealistic low values for pipe lengths and thermal capacity of the collector were included in the parametric study (e.g. Pipe lengths of 1 m, pipe heat loss coefficients of 0.028 W/K, solar collector thermal capacity of 1000 J/(m²K)).

Table 2: Values for the parametric study

Simulation number	Specific mass flow rate through collector [kg/(m ² h)] ^a	$\Delta T_{\text{coll,on}}$ [°C]	Set ΔT TES - collector	Pipe length TES - collector [m]	Heat loss TES - collector [W/K]	Heat exchanger	Stratification storage	Thermal capacity of the collector with contented fluid [J/(m ² K)]	Collector area [m ²]
1	40	7	-	15	3.8	Internal	No	7000	15
2	40	10	-	15	3.8	Internal	No	7000	15
3	40	4	-	15	3.8	Internal	No	7000	15
4	40	7	-	5	3.8	Internal	No	7000	15
5	40	7	-	15	3.8	Internal	No	3500	15
6	40	7	-	5	3.8	Internal	No	3500	15
7	40	7	-	15	1.9	Internal	No	7000	15
8	15	7	-	15	3.8	External	No	7000	15

9	60	7	-	15	3.8	Internal	No	7000	15
10	40	7	-	15	3.8	Internal	No	7000	5
11	40	7	-	15	3.8	Internal	No	7000	10
12	40	7	-	15	3.8	Internal	No	7000	20
13	15	7	-	15	3.8	External	Yes	7000	15
14	40	7	-	1	3.8	Internal	No	7000	15
15	13.3 - 40	10	10	15	3.8	Internal	No	7000	15
16	40	7	-	15	3.8	Internal	No	1000	15
17	13.3 - 40	10	10 ^b	15	3.8	Internal	No	7000	15
18	13.3 - 40	10	10	15	3.8	External	Yes	7000	15
19	15	7	-	5	3.8	External	No	7000	20
20	15	7	-	15	3.8	External	No	3500	20
21	13.3 - 40	10	10 ^b	15	3.8	Internal	No	1000	20
22	13.3 - 40	10	10 ^b	15	3.8	External	Yes	1000	20
23	15	7	-	1	0.028	External	Yes	1000	20
24	15	7	-	1	0.028	External	Yes	1000	15
25	15	7	-	1	0.028	External	Yes	1000	10
26	15	7	-	1	0.028	External	Yes	1000	5
27	13.3 - 40	10	10 ^b	1	0.028	External	Yes	1000	20
28	13.3 - 40	10	10	1	0.028	External	Yes	1000	20

a 15 kg/(m²h) for low flow, 60 kg/(m²h) for high flow, and 13.3 - 40 kg/(m²h) for match flow.

b This difference refers to the domestic hot water temperature (relative sensor height in the storage 0.65) and not to the average storage temperature like the other values that are given.

3. Results

4.1 Weather data analysis

For the statistical analysis of the weather data, first, all time steps with no direct irradiance were discarded from the TRY data sets for Zurich. The boxplot for the solar irradiance that is shown in Figure 2 and Table 3 show that with hourly averaged values high irradiance peaks are damped. For 6-min data resolution there are power peaks of more than 1200 W/m² that are not present for the hourly averaged values. Discarding time steps with no direct irradiance, the average irradiance is 245 W/m² for the 6-min data, which is 15.5 % more than for the hourly averaged data. The boxplots for ambient temperature on the other hand do not deviate substantially between the hourly averaged and the six minute resolution weather data – as could be expected from the nature of ambient temperature.

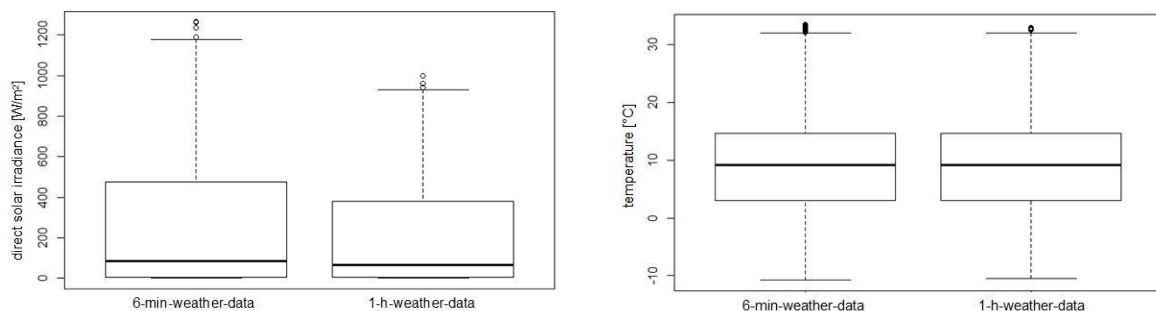

Figure 2: Boxplot of direct solar irradiance on 45 ° inclined south, and boxplot of the temperature distribution

Table 3: Mean value and standard deviation of solar irradiance on the 45 ° inclined south facing plane and for the temperature

	mean direct solar irradiance [W/m ²]	standard deviation for solar irradiance [W/m ²]	mean ambient temperature [°C]	standard deviation for ambient temperature [°C]
6-min-wd	244.58	287.80	9.036	7.735
1-h-wd	211.80	265.56	9.036	7.730

4.2 Simulation results of the reference system

Figure 3 shows the energy balance of the reference system during one year. The largest energy input is provided by the air sourced heat pump and by the solar collectors, followed by the electricity used by the compressor of the heat pump. 50 % of the heat is used for SH. The rest is distributed in equal parts to the DHW usage and to losses. The electrical energy consumption of the heating system is shown in Figure 4. Of this consumption, 88 % is used to run the heat pump (compressor and ventilator).

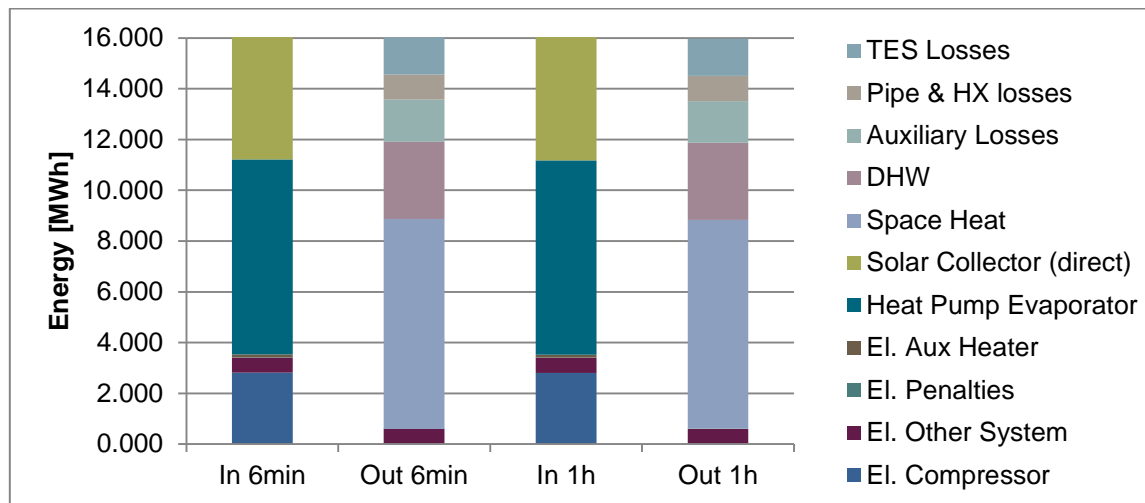

Figure 3: Energy balance (In/Out) of simulation 1 for 6 min and for hourly averaged weather data.

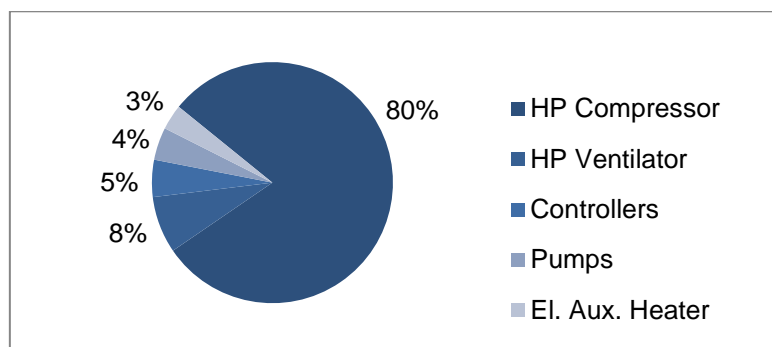

Figure 4: Distribution of electrical energy used in the system obtained with 6-min-wd.

Table 4 shows the most important simulation results of the reference system. Values are given for the simulation with 6 minute time steps and for the simulation with hourly averaged weather data. The difference (Dif.) between the 6-min and 1-h-wd values x is calculated as:

$$Dif. = 100 \% \times \frac{(x_{1-h-wd} - x_{6-min-wd})}{(x_{6-min-wd})} \quad (eq.1)$$

Table 4: results of simulation one (reference system)

	6-min-wd	1-h-wd	Dif. [%]
domestic hot water demand [MWh]	3.038	3.038	0.00
space heating demand [MWh]	8.273	8.223	-0.60
collector yields [MWh]	4.911	4.908	-0.06
heat pump gains [MWh]	7.679	7.646	-0.43
consumption of electricity ¹ [MWh]	3.537	3.527	-0.28
seasonal performance factor (SPF)	3.198	3.193	-0.16

¹ The consumption of electricity contains the electric consumption of the heat pump compressor, penalties, electrical auxiliary heating and other systems like pumps, controllers and heat pump ventilator.

The space heating demand was always 0.6 % (+50 kWh) higher when using 6-min-wd in comparison to 1-h-wd. The collector yield is only 0.06 % (+3 kWh) more with 6-min-wd. The main part of the additional space heating demand for the 1-h-wd is provided by the heat pump (+33 kWh), thus leading also to a larger consumption of electricity (+10 kWh). But the SPF is slightly better when using 6-min-wd in the reference simulation.

4.3 Results from the parametric study

In comparison to the reference system some system parameters (dark coloured in Table 2) were changed in simulations 2 to 28 as described in section 3.4. Based on an analysis of the results from simulations 1 to 18 a new set of systems (19 to 28) was created that was expected to be more sensitive to the weather data time resolution. Figure 5 and Figure 6 show the differences between 6-min-wd and 1-h-wd for collector yield, seasonal performance factor, and electricity consumption.

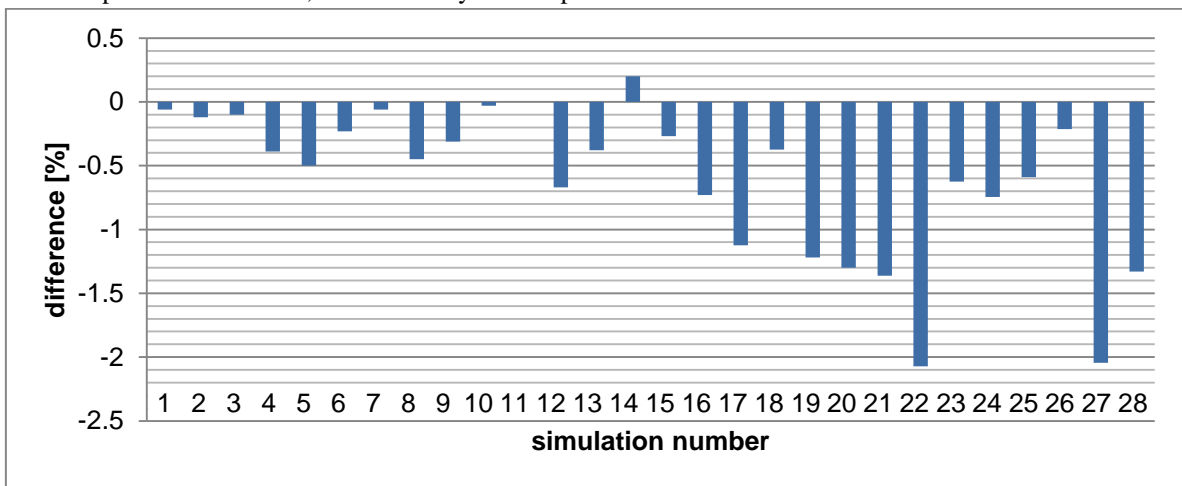

Figure 5: Deviations of collector yield between hourly averaged and 6 minutes weather data simulations.

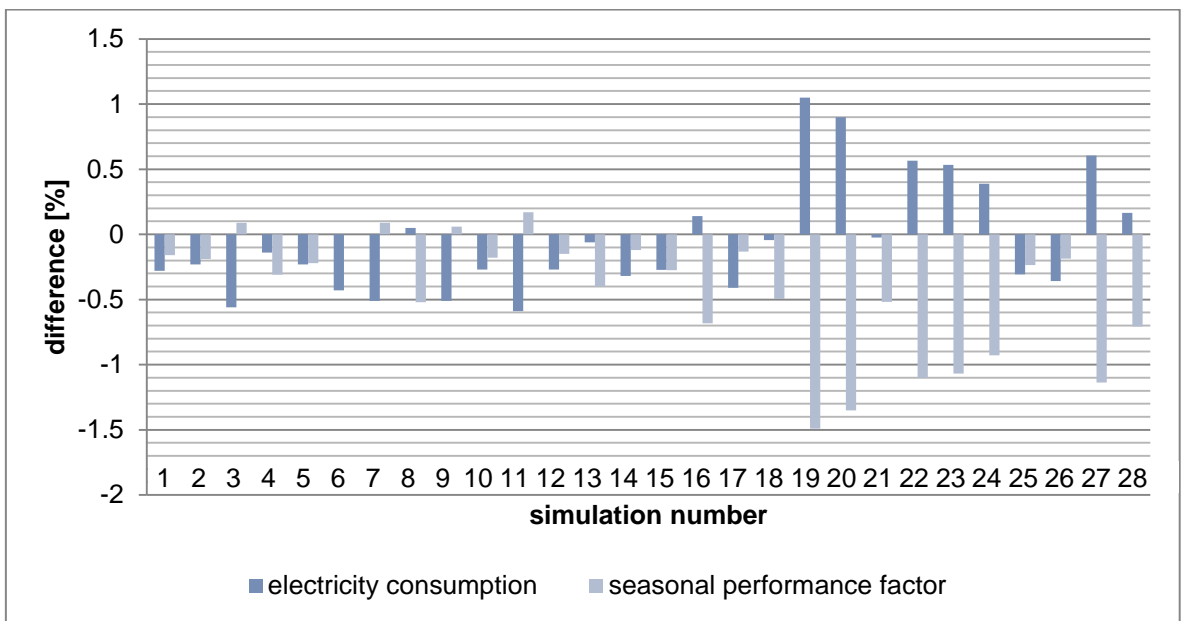

Figure 6: Deviations of electricity consumption and seasonal performance factor between hourly averaged and 6 minutes weather data simulations.

4.4 Utilizability

It should be noticed that no physical system (with thermal capacity and inertia) is necessary to calculate the utilizability. A comparison of the utilizability for the 6-min-wd and the 1-h-wd (Figure 7) for the TRY data of Zurich shows a similar result like the one of Vijayakumar et al. (2005). At a critical irradiance of 800 W/m² the difference in utilizability is 51 % between the 6-min and the hourly averaged data. In general, the higher the critical irradiance, the higher the utilizability difference. Due to the averaging, the irradiance peaks are dampened in the 1-h-wd and do not reach values above 1000 W/m². Therefore the difference can increase

to 100 % above a critical irradiance of 1000 W/m². The critical irradiance value of the collector that was used for the simulation study is 122 W/m² (efficiency = 0 % for 0 °C ambient temperature and 30/35 °C collector temperature). For this critical irradiance a difference of 4 % is obtained for the utilizability when comparing 1-h and 6-min-wd.

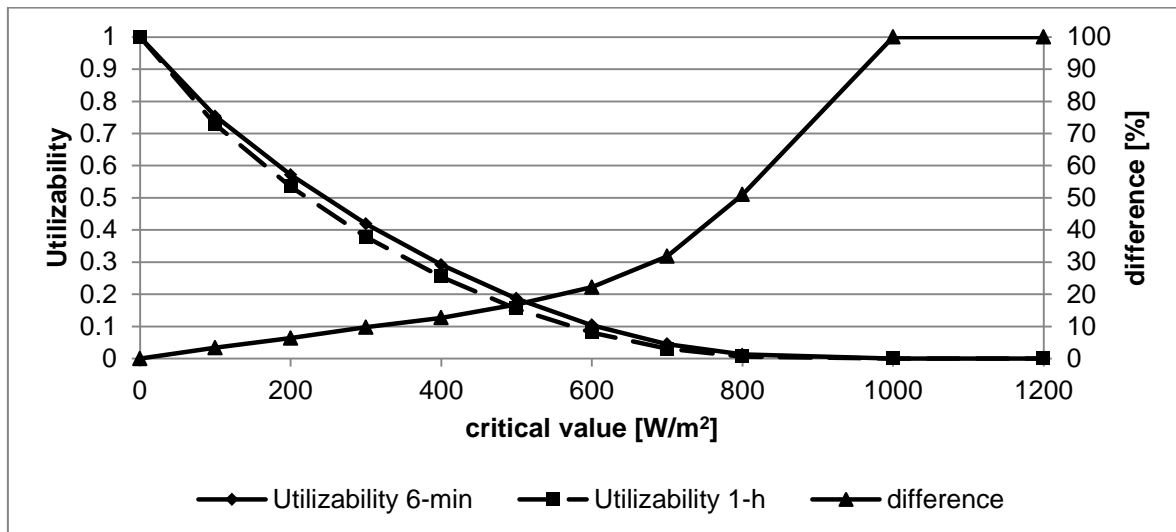

Figure 7: Utilizability of the used weather data at different critical irradiance levels.

4. Conclusion

Unlike averaging temperatures over one hour, averaging measured irradiance values over one hour changes the statistical distribution, dampens high irradiance peaks, and reduces the mean irradiance value for the climatic data of Zurich that was investigated. As a consequence - as shown by previous studies - the utilizability method gives much lower utilizability for hourly averaged weather data than for weather data of higher time resolution, especially for critical irradiance values that are high (e.g. > 500 W/m²).

When hourly averaged weather data was used instead of the 6-min weather data resolution, the collector yield of the reference system simulation was 0.06 % lower and the electricity consumption was 0.28 % lower. The SPF was slightly worse (-0.16 %). It should be noticed that the space heating demand is also 0.6 % lower when simulating with hourly averaged weather data. Thus, the largest effect of weather data averaging for this system is not on the solar thermal loop, but on the energy balance of the building.

If only small changes on single parameters of the reference system are made, then the influence of the weather data resolution on the collector yield, electricity consumption, and SPF remain also small. By changing only one parameter at a time, the difference of collector yield reached a maximum of 1.12 % for a matched collector flow system (simulation 17). The maximal differences of collector yield (-1.22 %) and electricity consumption (+1.05 %) for a realistic system was calculated for a low-flow system with a larger collector area of 20 m² (simulation 19). In this simulation, the heat transfer from the collector loop to the TES is realized with an external heat exchanger.

An extreme (rather unrealistic) decrease of the thermal capacity in the collector loop (e.g. in simulation 22) resulted in a maximum deviation of 2 % in collector yield and 1.5 % in SPF of the system, which indicates that the thermal capacitance of real systems reduces the difference between simulations that are performed with hourly averaged weather data instead of higher time resolutions of 6 minutes. This may explain at the same time the difference between the results from the utilizability method - where no thermal capacity of the collector loop is taken into account - and system simulations. It can be concluded that the thermal capacity that is present in real systems has a similar effect as the averaging of irradiance over one hour: it reduces the utilizability of short irradiance peaks and dampens the influence of short fluctuations of irradiance on the temperatures that arrive at the TES.

5. Outlook and recommendations

Overall, averaging weather data from 6-10 minutes to 1 hour may change the simulation results in the order of 1 % for solar yield and purchased (electric) energy, for system simulations with realistic thermal capacity in the collector loop, and in the order of 2 % for unrealistically low thermal capacity in the collector loop. Therefore, hourly weather data may be used with little error for the simulation of solar thermal systems. This

has been confirmed for a number of simulations for solar and heat pump systems of the parallel type. However, it remains an open question whether this applies also for series solar and heat pump concepts or parallel/series combinations.

6. Acknowledgement

The research leading to these results has received funding from the European Union's Seventh Framework Programme (FP7/2007-2013) under grant agreement n° 282825.

7. Bibliography

- Bales, C., 2012. Definition of Boundary Conditions, Deliverable 7.1 – Final – 28 June 2012, MacSheep - New Materials and Control for a next generation of compact combined Solar and heat pump systems with boosted energetic and exergetic performance.
- Baoxin, Z., 2009. How the different time steps weather data affect the simulation results of solar combisystems. Master Thesis, European Solar Energy School, Högskolan Dalarna, Sweden.
- Dott, R., Haller, M.Y., Ruschenburg, J., Ochs, F. & Bony, J., 2013. The Reference Framework for System Simulations of the IEA SHC Task 44 / HPP Annex 38 - Report C1 Part B: Buildings and Space Heat Load - Final Revised.
- Drück, H., 2006. Multiport Store-Model for TRNSYS, Stratified fluid storage tank with four internal heat exchangers ten connections for direct charge and discharge and an internal electrical heater, Type 340, Version 1.99F.
- Duffie, J.A. & Beckman, W.A., 1980. Solar Engineering of Thermal Processes. John Wiley & Sons Inc.
- Haberl, R., Frank, E. & Vogelsanger, P., 2009. Holistic System Testing - 10 Years of Concise Cycle Testing. In: Solar World Congress 2009, Johannesburg, South Africa, 351–360.
- Haller, M.Y., Dott, R., Ruschenburg, J., Ochs, F. & Bony, J., 2013a. The Reference Framework for System Simulations of the IEA SHC Task 44 / HPP Annex 38 - Report C1 Part A: General Boundary Conditions - Final Revised. Report C1 Part A.
- Haller, M.Y., Haberl, R., Persson, T., Bales, C., Kovacs, P., Chèze, D. & Papillon, P., 2013. Dynamic whole system testing of combined renewable heating systems – The current state of the art. Energy and Buildings, 66, p.667–677.
- Haller, M.Y., Perers, B., Bales, C., Paavilainen, J., Dalibard, A., Fischer, S. & Bertram, E., 2012. TRNSYS Type 832 v3.10 „Dynamic Collector Model by Bengt Perers“ - Updated Input-Output Reference.
- Heinz, A. & Haller, M.Y., 2012. Description of TRNSYS Type 877 (v112).
- Jordan, U. & Vajen, K., 2005. DHWcalc: program to generate domestic hot water profiles with statistical means for user defined conditions.
- Suehrcke, H. & McCormick, P.G., 1989. Solar radiation utilizability. Solar Energy, 43(6), p.339–345.
- Vijayakumar, G., Kummert, M., Klein, S.A. & Beckman, W.A., 2005. Analysis of short-term solar radiation data. Solar Energy, 79(5), p.495–504.
- Vogelsanger, P., 2002. The Concise Cycle Test Method - A Twelve Day System Test - A Report of IEA SHC - Task 26. International Energy Agency Solar Heating and Cooling Programme.